



ALLMATIC PRODUCT FINDER

THE FAST WAY TO THE RIGHT PRODUCT!

Do you want 24/7 support? No problem! Our product finder is available to you around the clock at www.allmatic.de.



Our ALLMATIC product finder is in the top right-hand corner of the main menu.



You can choose between two finders. You can use our quick filter for a fast, time-saving search. Here you can find what you are looking for with just a few clicks.



You can use our product finder for a more detailed, precise search. Here you can enter dimensions, for example the height and width of your workpiece. A detailed set of product, jaws and accessories is compiled based on your specifications, which you can conveniently place in the shopping basket.

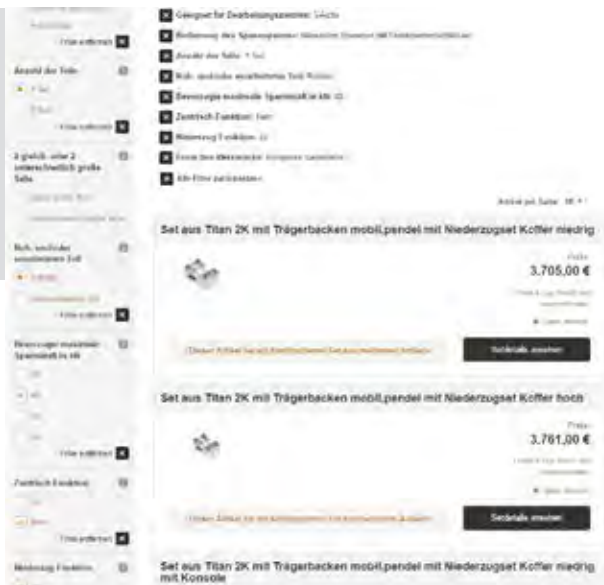

A selection of suitable products is produced when you have finished entering the details.

Please note, however, that the quality of results obviously depends on how detailed your input is. The more details our filter receives, the more precise the output of the product sets is.





Product finder

Function 2

About us

Management 4

Our philosophy 5

Automation/ Serial production

Product information

Clamp drive 6

Clamping towers 7

Clamp assist (CA)

Product information

Mobile receiver unit (MRU) 8

TITAN 2 K-M-L/160 (CA) 9

GRIPP series – mechanical

Product information

TITAN 2 K-M-L/160 9

TELECENTRIC 70 K-M 14

CENTRO Gripp 16

T-REX 18

TITAN SC 125 20

DUO Plus 125 22

NC series – mechanical

Product information

NC8 24

DUO 90 28

HD – mechanical

Product information 29

Hydraulic LCH

Product information 30

LCH 

Terms and conditions

www.allmatic.de

**“ALLMATIC HAS BEEN BRINGING YOU
QUALITY, PRECISION AND FLEXIBILITY
SINCE 1973.”**



Managing Director: Mr Bernhard Rösch

1973

We are specialists.

ALLMATIC is a specialist in the field of workpiece clamping systems and offers an impressive range of intelligent clamping solutions. We develop precise clamping and holding systems to the highest quality standards for demanding cutting tasks in milling and machining centres. We are the market leader in the high pressure clamping segment.

We love perfection.

The force of innovation and a passion for precision are at the core of our brand. Our drive for maximum quality and reliability derives from our pursuit of perfection and fascination with new technologies. ALLMATIC is characterised by reliable products, expert support and first class service as well as fair, long-term co-operation with customers, business partners and employees.

We inspire.

Our enthusiasm for the efficiency of our products, our profound knowledge, personal support and active contribution to designing future solutions guarantee a long-term and active partnership.

“OUR CUSTOMERS BENEFIT FROM OUR EXPERIENCE, KNOW-HOW AND TECHNICAL EXPERTISE.”

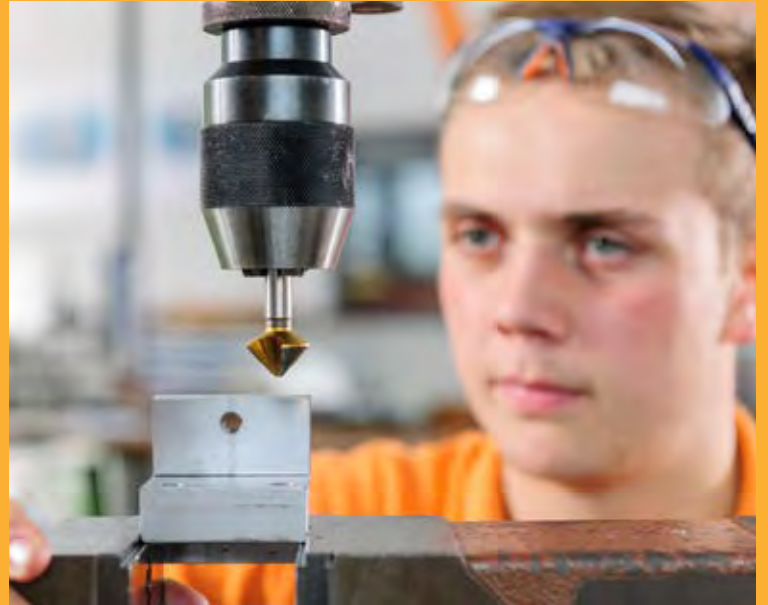

Our philosophy:

We place our many years of experience, the know-how thus gained and our technical expertise at the disposal of our customers. Our aim is to make an important contribution to the productivity and competitiveness of our customers. We are committed to assisting our customers by providing them with advice, support and our capacity for innovation.

Our products are characterised by their high quality. We only achieve this by setting high standards. Perfection, passion and enthusiasm are the driving forces that motivate our team. Fair co-operation of our employees is just as important to us as a good relationship with suppliers and customers, for whom we are a reliable and trustworthy partner.

AUTOMATING? WITH EXISTING CLAMPING SYSTEMS?

Idea

Automate conventional vices and monoblocks.
(Single & DUO)

Users

Users of existing and newly planned machining centres.
With and without pallet changer!

Installation

PLUG and PLAY!
Fast installation thanks to
PROFIBUS interface!

Individual

Individual customer solutions!

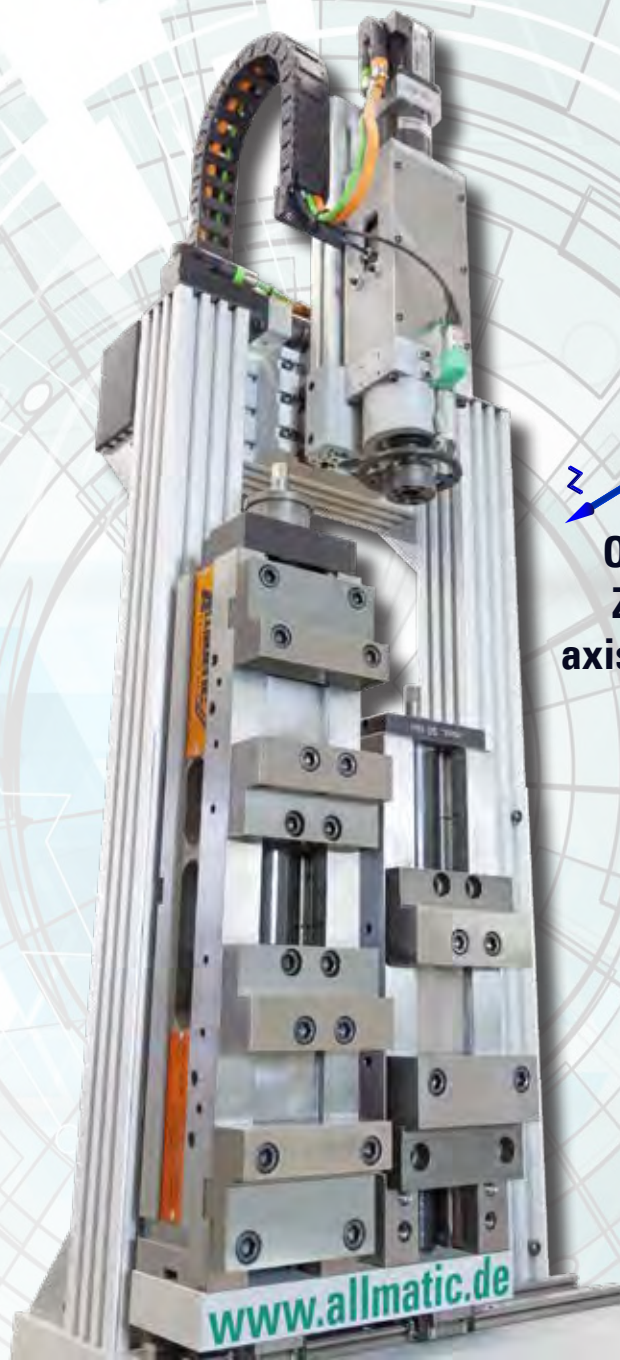

**Clamp
drive**

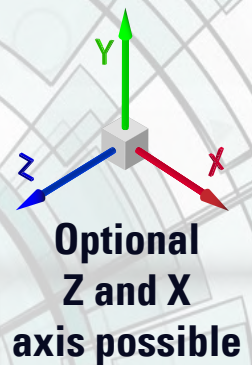

CLAMPING TOWERS

In addition to the standard products, ALLMATIC offers a wide variety of clamping towers. Every clamping tower can be individually adapted to your machine, workpiece and machining technologies.

Area of application:

- Modular clamping system for machining centres

Product features:

- High stability due to a basic body
- Clamping towers consist of standard modules
- Very good accessibility even with large workpieces
- High pressure spindle with mechanical power converter
- Individual adaptation to your machine (pallet, travels and workpieces) is possible



3 x 120° Single TITAN2



4 x 90° Single



4 x 90° DUO 90



3 x 120° DUO PLUS 125



4 x 90° DUO PLUS 125



Back-to-back / H-profile



MONOBLOCK SINGLE & DUO



Special customised solutions



6-compartment design DUO 125 on double bracket



DUO 125 4 x 90° with special width-reduced jaws for 1st and 2nd clamping



Special design of Monoblock DUO 125 4 x 90° for machining complex cast parts







Technical details are available at www.allmatic.de

CLAMP ASSIST - CLAMPING FORCE MEASUREMENT

The electronic measurement system is cast into the power spindle and sends the current clamping forces to the mobile receiver unit outside of the machine. No cables or power source required. The system works completely independently.

Electronic spindle TITAN 2 Clamp assist

| | |
|-----------------------------------------------------------------------------------|--------------------------------------------------------|
|  | Storage location of the spindles. |
|  | Current clamping force of the spindle. Measured in kN. |
|  | Signal strength of the spindle. |
|  | Rest mode, the signal is updated every 12 secs. |



Mobile receiver unit (MRU):
696100100000

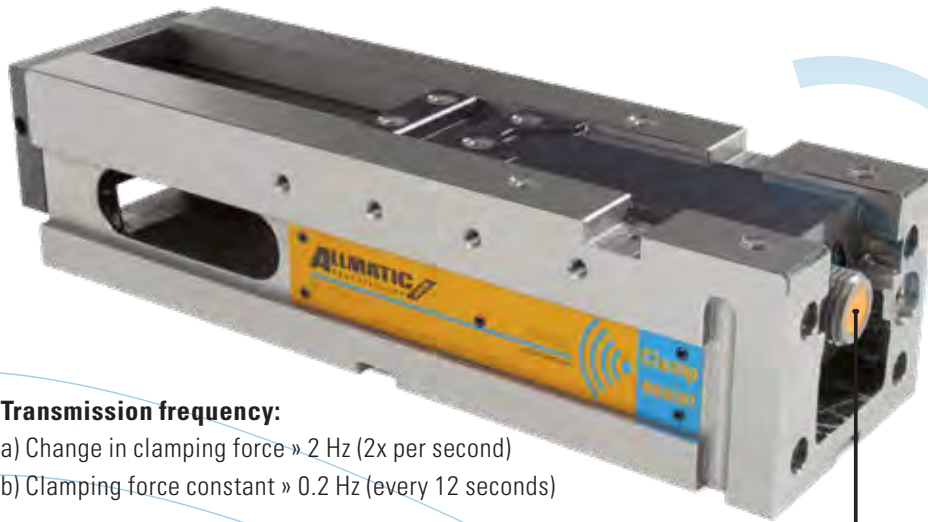

Transmission frequency:

- Change in clamping force » 2 Hz (2x per second)
- Clamping-force constant » 0.2 Hz (every 12 seconds)



Fully encapsulated high-pressure spindle (IP67)

User-friendly energy management:
Battery life approx. 4 years (2-shift operation)

The electronic system stores the clamping cycles or changes in clamping forces. The data is stored in the spindle, ready for transmission at any time.

Function:

- Recording of the current clamping forces in the fully encapsulated high-pressure spindle by means of an integrated, electronic measurement system and transmission to the mobile receiver unit (MRU)
- Recording independently of clamping jaws, as the measuring system is integrated in the spindle
- When clamped, the clamping force is permanently monitored (also with grip and hold-down clamping)
- The electronic system integrated in the system stores the clamping forces, which can be called at any time
- Force values are transferred to the mobile receiver unit via radio (2.4 GHz)
- MRU displays the clamping force digitally in kN of up to 4 spindles simultaneously
- The clamping force pre-set by the user (reference force) is displayed on the MRU by an LED when 90% is reached
- The last 200 stored clamping processes can be transmitted in CSV-format

Characteristics:

- The dimensions of the vices remain unchanged
- Robust MRU for use in the workshop area
- The service life of the batteries of the transmission unit is up to 4 years (2-shift operation) due to efficient energy management
- Charging of the MRU possible via USB 2.0 connection



High-pressure spindle with measuring sensor system

Insensitive to vibrations and coolants

Max. transmission and reception distance 20 metres

TITAN 2 K-M-L

125

TITAN 2 - with 3 construction lengths - the decisive extra for your machining task. Even more universal - even more flexible, whether in height or in length, whether for conventional clamping or grip clamping, the TITAN 2 leaves nothing to be desired.

Area of application:

- Can be used horizontally and vertically
- Conventional clamping, grip clamping and draw-down clamping are possible
- Pre-machined parts and also unmachined parts of a wide variety of materials and complex geometries can be securely clamped



Product features:

- Increased power stroke for secure positive locking with the required clamping force on the workpiece
- Provided as standard with locating holes for a zero point clamping system inside micrometer 200 for TITAN 2 K and M
- Jaws of the product range LC / TC 125 can be used

CLAMP ASSIST & MECHANICAL

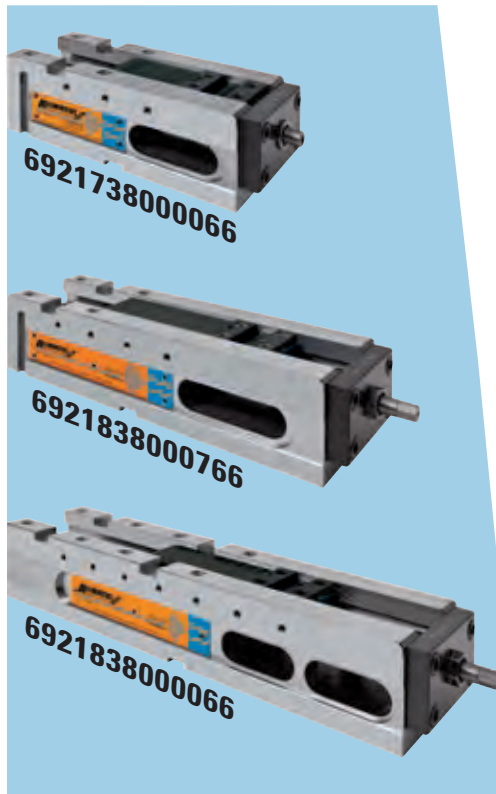

K

M

L

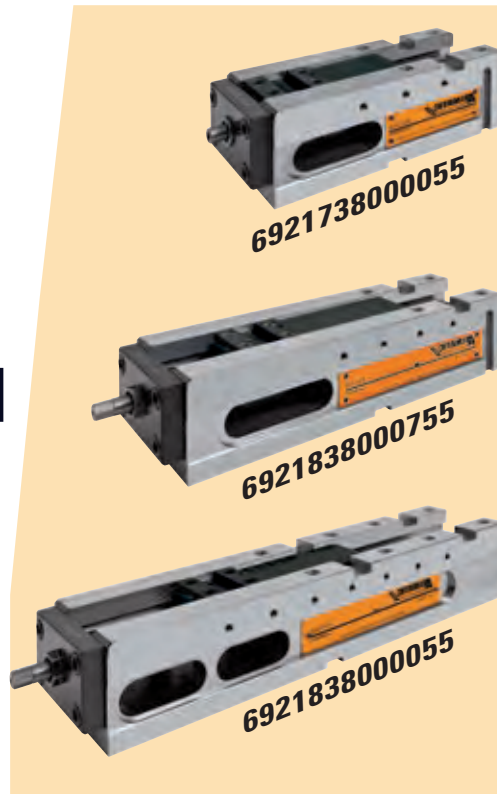

TITAN 2-160

160

TITAN 2-160 - Heavy Duty Cutting. Made for big things. Big workpieces - big machines - that's its world. The TITAN 2-160 opens new doors in the segment of clamping of large parts.

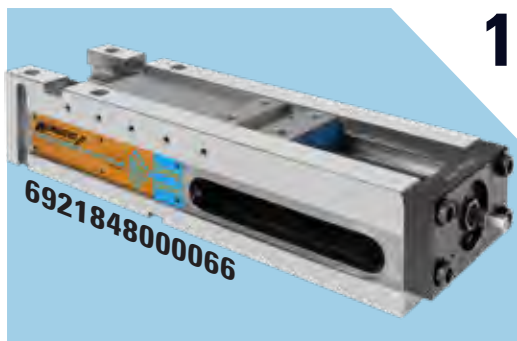

160



Technical details are available at www.allmatic.de

TITAN 2 K-M-L/160

CONVENTIONAL CLAMPING

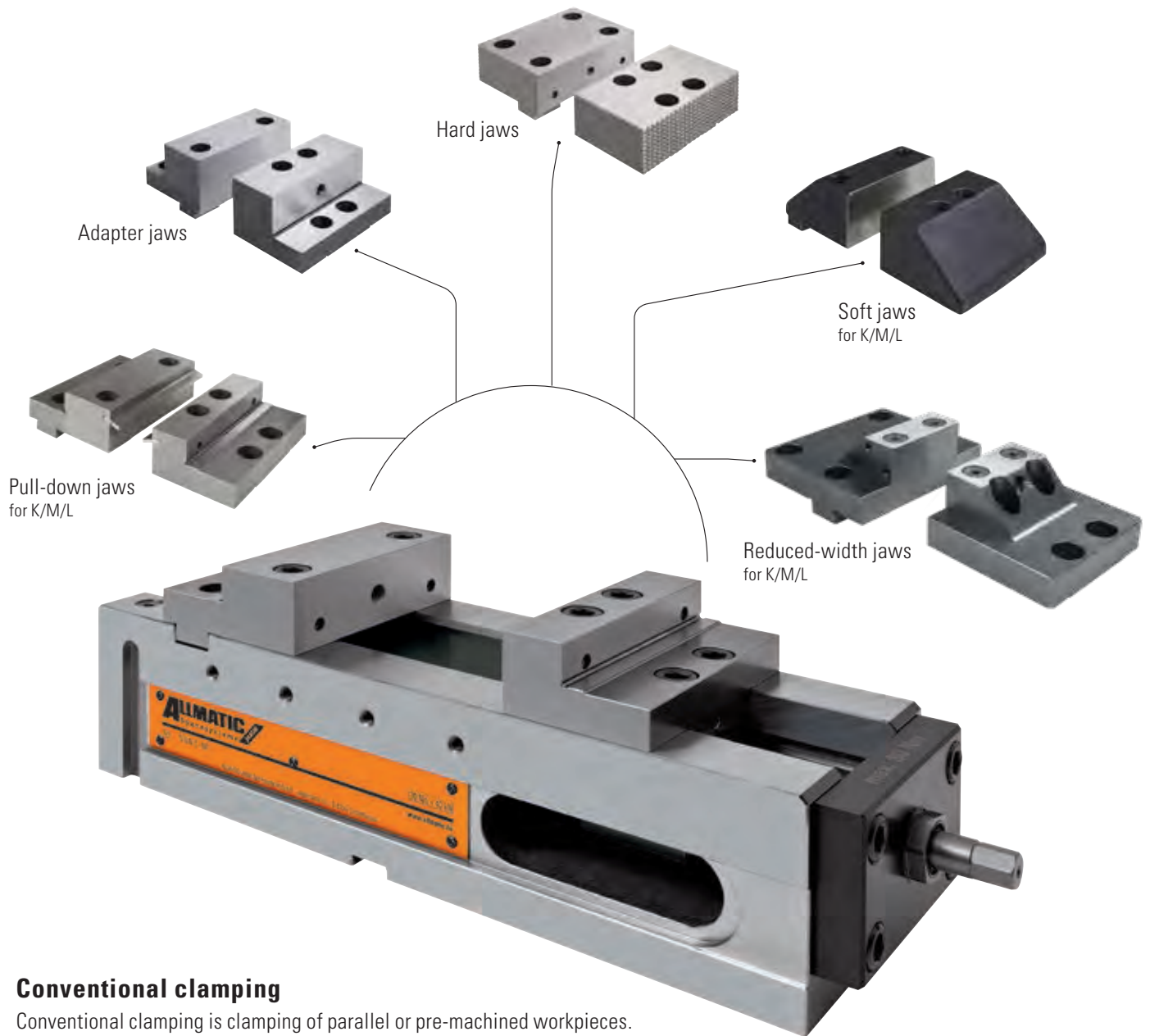

Conventional clamping

Conventional clamping is clamping of parallel or pre-machined workpieces.



TITAN 2 K-M-L/160

GRIPP CLAMPING

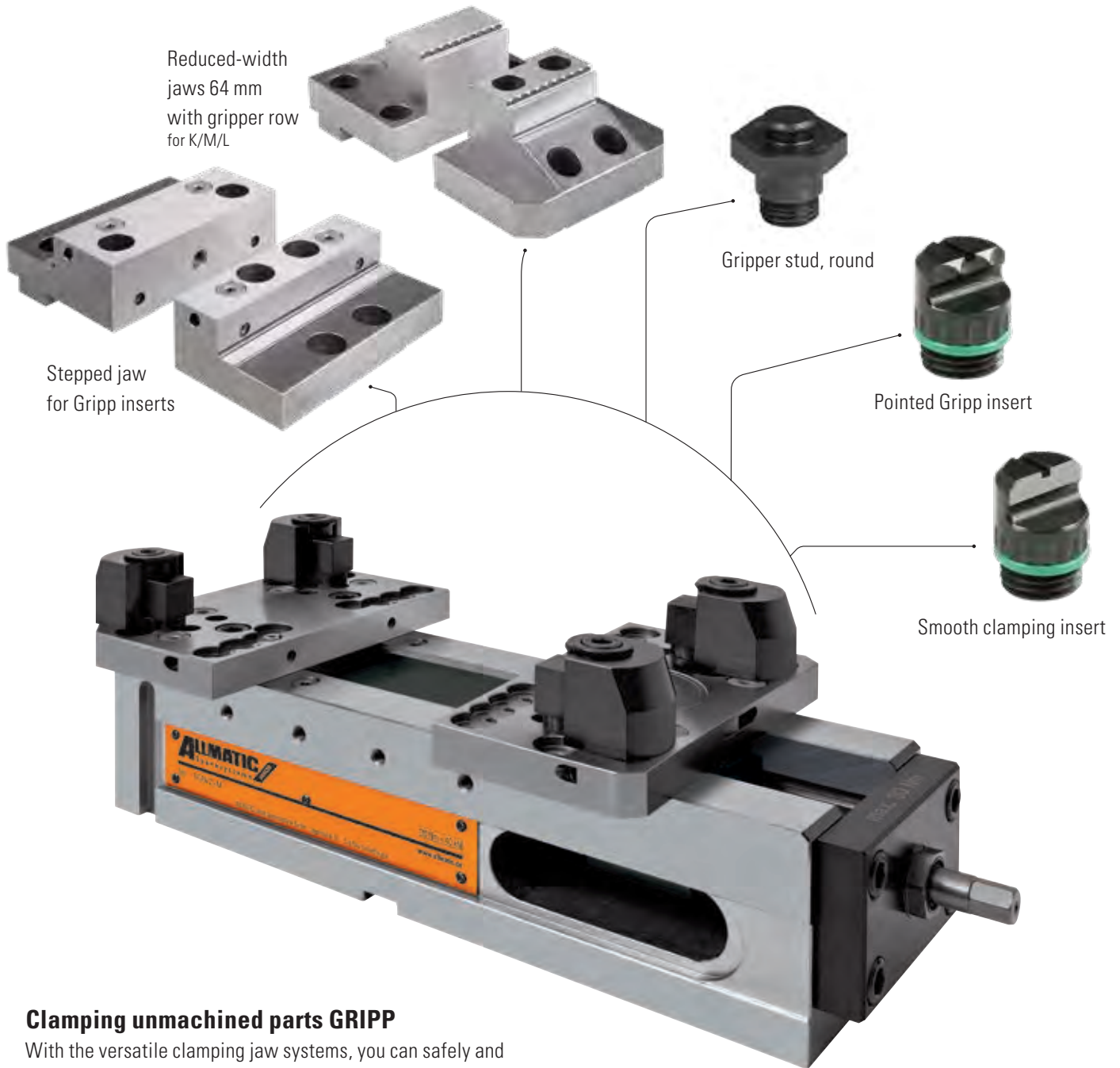

Clamping unmachined parts GRIPP

With the versatile clamping jaw systems, you can safely and quickly clamp unmachined, non-parallel raw materials or workpieces.

The jaw widths of TITAN 2 depend on the positioning of the Gripp inserts or of the universal Gripp set on the clamping jaw systems.

The geometry you wish to clamp is irrelevant here. The adjustment options of our Gripp inserts or of our universal Gripp set allow unlimited clamping options.



Technical details are available at www.allmatic.de

TITAN 2 K-M-L/160

HOLD-DOWN CLAMPING

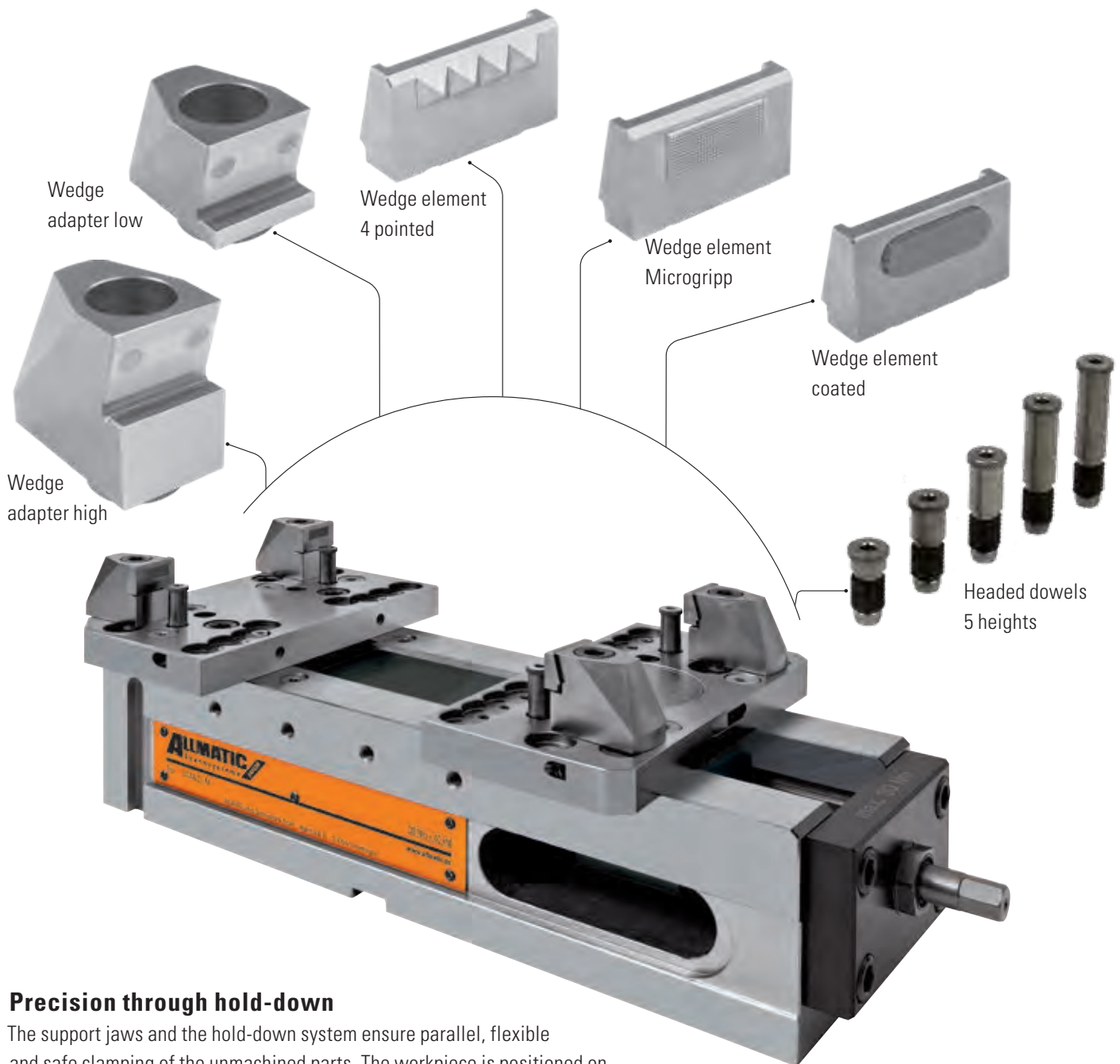

Precision through hold-down

The support jaws and the hold-down system ensure parallel, flexible and safe clamping of the unmachined parts. The workpiece is positioned on ground headed dowels which make the connection to the guideway. This transfers the parallelism with the guideway or the machine table to the workpiece. Based on this principle, the vibrations are avoided to a great extent, thus achieving surfaces of better quality and service lives of tools increased.



TITAN 2 K-M-L

5-SIDED JAW

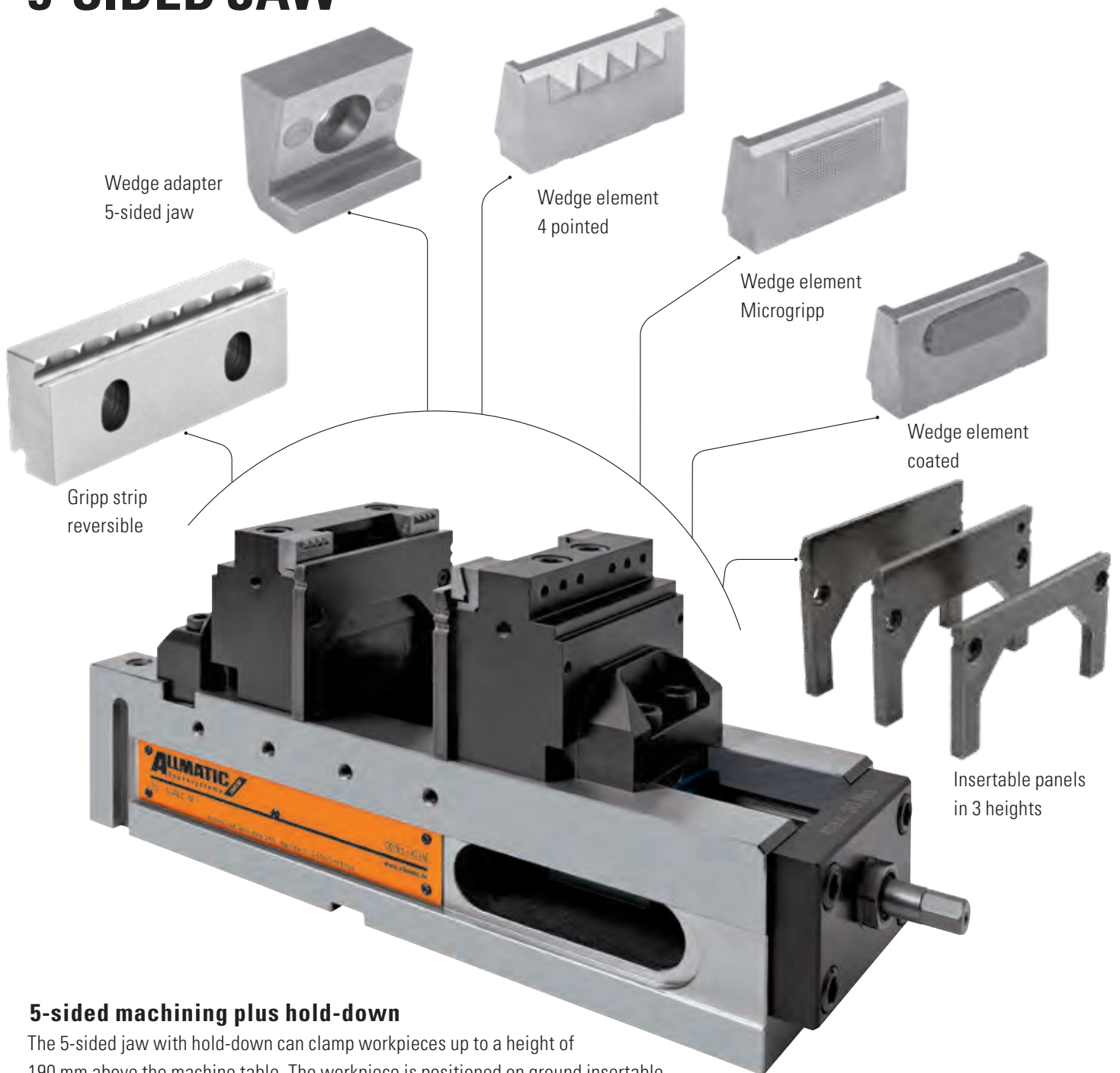

5-sided machining plus hold-down

The 5-sided jaw with hold-down can clamp workpieces up to a height of 190 mm above the machine table. The workpiece is positioned on ground insertable panels, which make the connection to the guideway. This transfers the parallelism with the guideway or the machine table to the workpiece. Based on this principle, the vibrations are avoided to a great extent, thus achieving surfaces of better quality and service lives of tools increased. The particular advantage of the 5-sided jaw is the accessibility with short tools.



TELECENTRIC 70 K-M

5-AXIS-CENTRAL CLAMP

TeleCentric, the centric clamp for 5-sided machining. Due to the construction type and the centric telescopic spindle, the disturbing contours remain independent of the chuck capacity. Excellent accessibility is ensured from all sides. The quick change jaw system fitted as standard reduces tooling times and increases flexibility.

Area of application:

- Ideal for use on 5-axis machining centres
- Conventional clamping and Gripp clamping possible

Product features:

- Telescopic spindle, interference contour remains unchanged
- Central, simple programming without zero point offset
- The allowance of the material is symmetrically distributed
- Accessibility of the workpiece depends on the chuck capacity
- Symmetrical construction shape.
Workpiece remains central and parallel
- Support height of the workpiece 192 mm
- Quick change jaw system, tool-free jaw change due to quick-action closure within 10 seconds per jaw pair
- Reversible jaws: for min. / max. chuck capacities with one pair of jaws
- Constant clamping force via low-maintenance telescopic spindle
- Provided as standard with locating holes for a zero point clamping system, inside micrometer 200
- Integrated scaling for fine adjustment of the central position
- Low weight (without jaws): K = 17.5 kg / M = 19.5 kg
- Clamping force 30 kN at 45 Nm linear
- Operation with torque spanner



70 K: 6921548000055

70 M: 6921548000155

CONVENTIONAL CLAMPING



Step jaw b38
Carbide coated

Step jaw b70
Carbide coated

Step jaw b100
Carbide coated

Prismatic jaw b70
Horizontal Ø12 - Ø40
Vertical Ø19 - Ø74

Smooth jaw b120

Conventional clamping

In the case of conventional clamping, parallel, pre-machined or level workpieces or materials are clamped. Generally, conventional clamping is used for the second clamping process or for workpieces with parallelism errors of up to 0.05 mm.

GRIPP CLAMPING

GRIPP clamping

With GRIPP clamping, unmachined, non-parallel workpieces or raw materials are clamped.

Workpiece pre-milled:

- Strength up to 1,000 N/mm²

Raw materials:

- Strength up to 550 N/mm²
- Parallelism error up to 0.3 mm



CENTRO GRIPP - WITH THE TEETH AT THE CENTRE!

The CENTRO GRIPP impresses due to its extreme accuracy and durability. The workpiece is always centrally clamped both for conventional clamping and clamping of unmachined parts. Ideal for use in 5-sided machining.



Area of application:

- Can be used horizontally
- Ideal for use on 5-axis machining centres due to its compact design
- Depending on the clamping jaws, pre-machined workpieces and unmachined parts can be clamped

Product features:

- The centre of the clamp is adjustable. The position of the workpiece remains within narrow limits.
- Repeatability $\pm 1/100$ mm with right-angled workpieces
- Stamping and clamping takes place in one work step
- Operation with torque spanner
- Provided as standard with locating holes for a zero point clamping system, inside micrometer 200

CONVENTIONAL CLAMPING

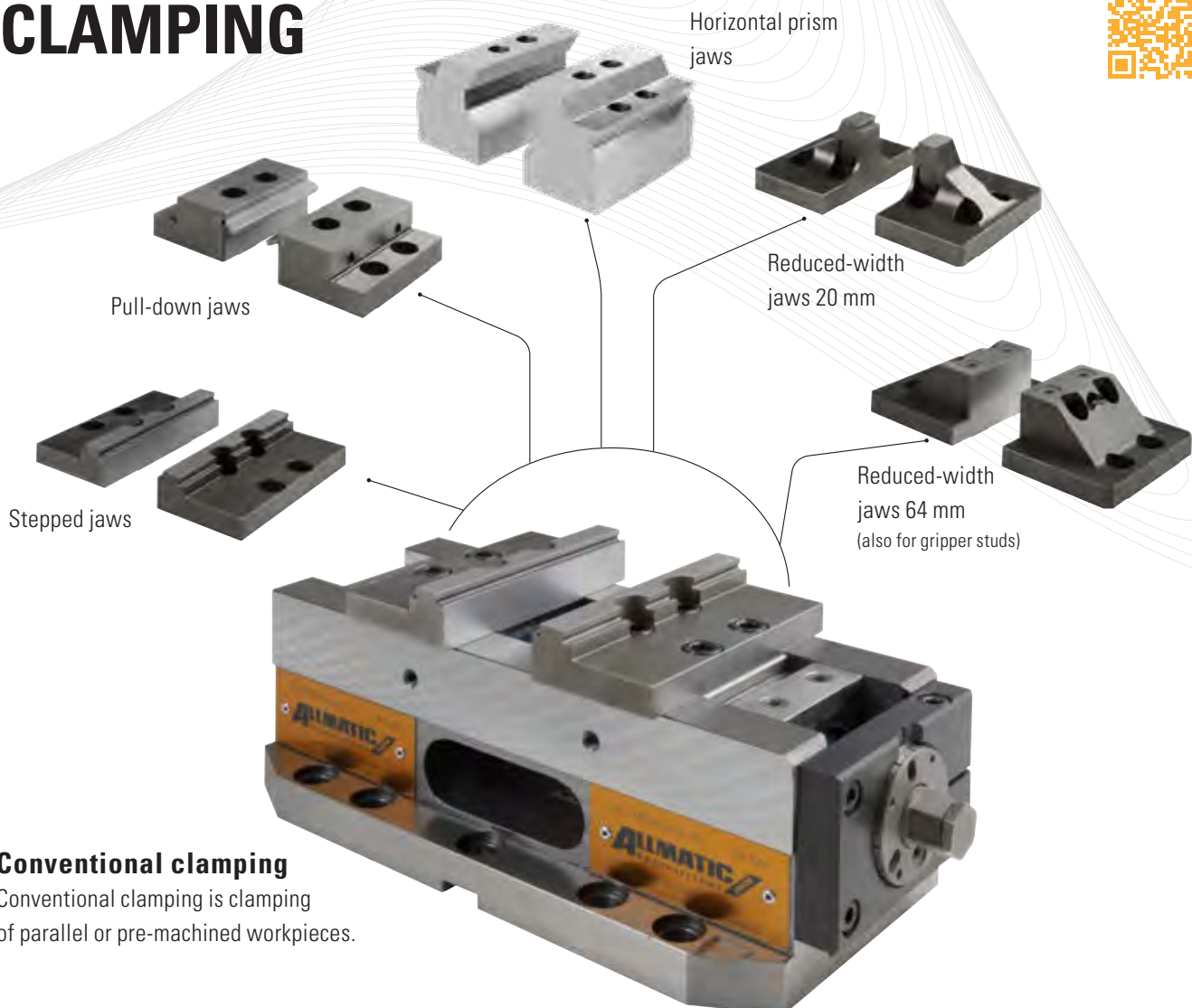

Conventional clamping

Conventional clamping is clamping of parallel or pre-machined workpieces.

GRIPP CLAMPING

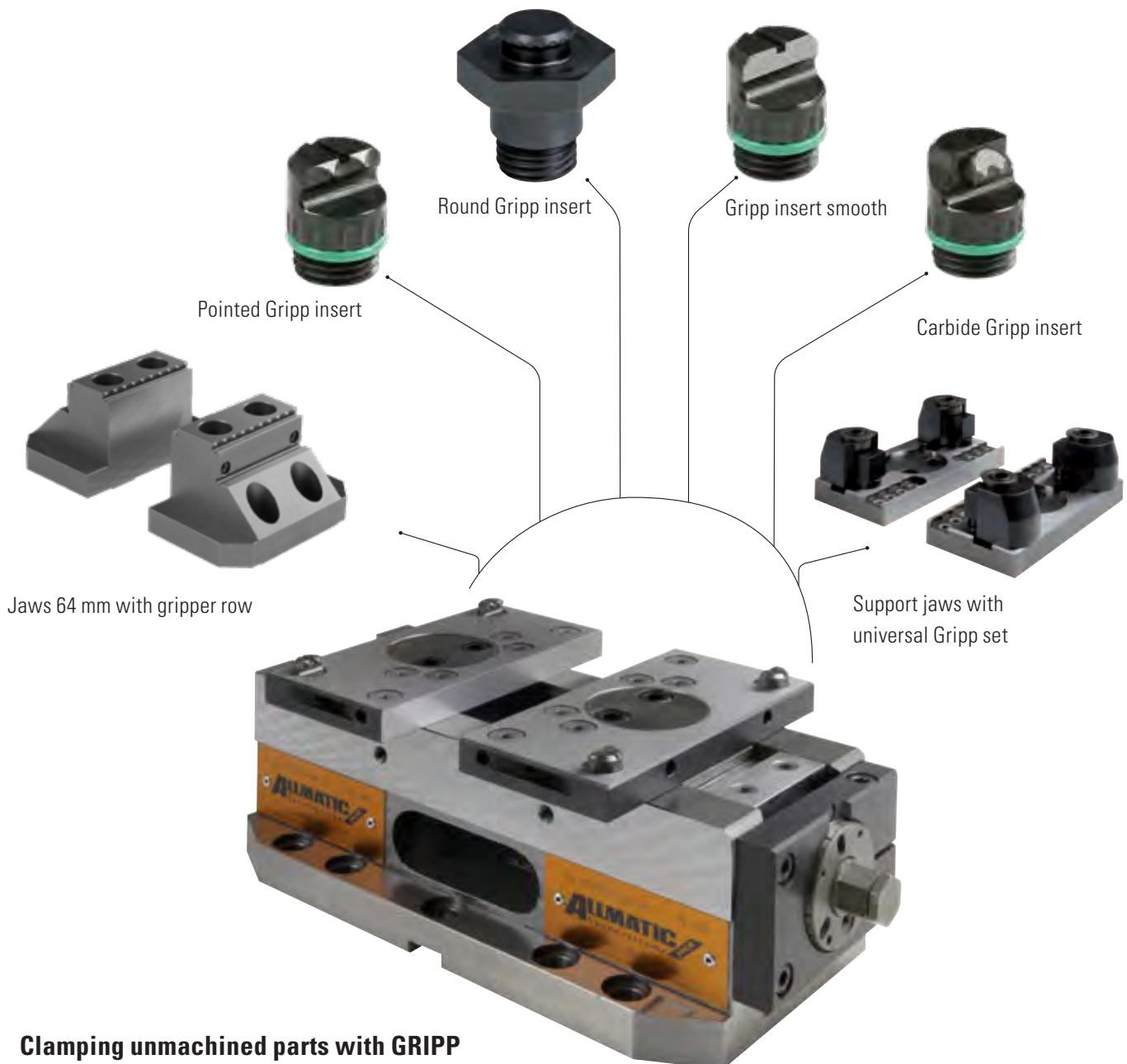

Clamping unmachined parts with GRIPP

With the versatile clamping jaw systems, you can safely and quickly clamp unmachined, non-parallel raw materials or workpieces.

The jaw widths of the CENTRO GRIPP depend on the positioning of the Gripp inserts or of the universal Gripp set on the jaw systems. The geometry which you wish to clamp is irrelevant here. The adjustment options of our Gripp inserts or of our universal Gripp set allow unlimited clamping options.



Technical details are available at www.allmatic.de

T-REX

BEWARE, IT BITES!

Its compact size and sharp "teeth" of its grippers dig into your workpiece and make the T-REX an indispensable tool for unmachined part clamping with 5-sided machining.



Area of application:

- Can be used horizontally
- Ideal for use on 5-axis machining centres due to its compact design
- Depending on the clamping jaws, pre-machined workpieces and unmachined parts can be clamped

Product features:

- Stamping and clamping takes place in one work step
- Optimum accessibility for 5-sided machining due to compact basic body and simultaneously large chuck capacity
- Operation with torque spanner
- Provided as standard with locating holes for a zero point clamping system, inside micrometer 200

CONVENTIONAL CLAMPING

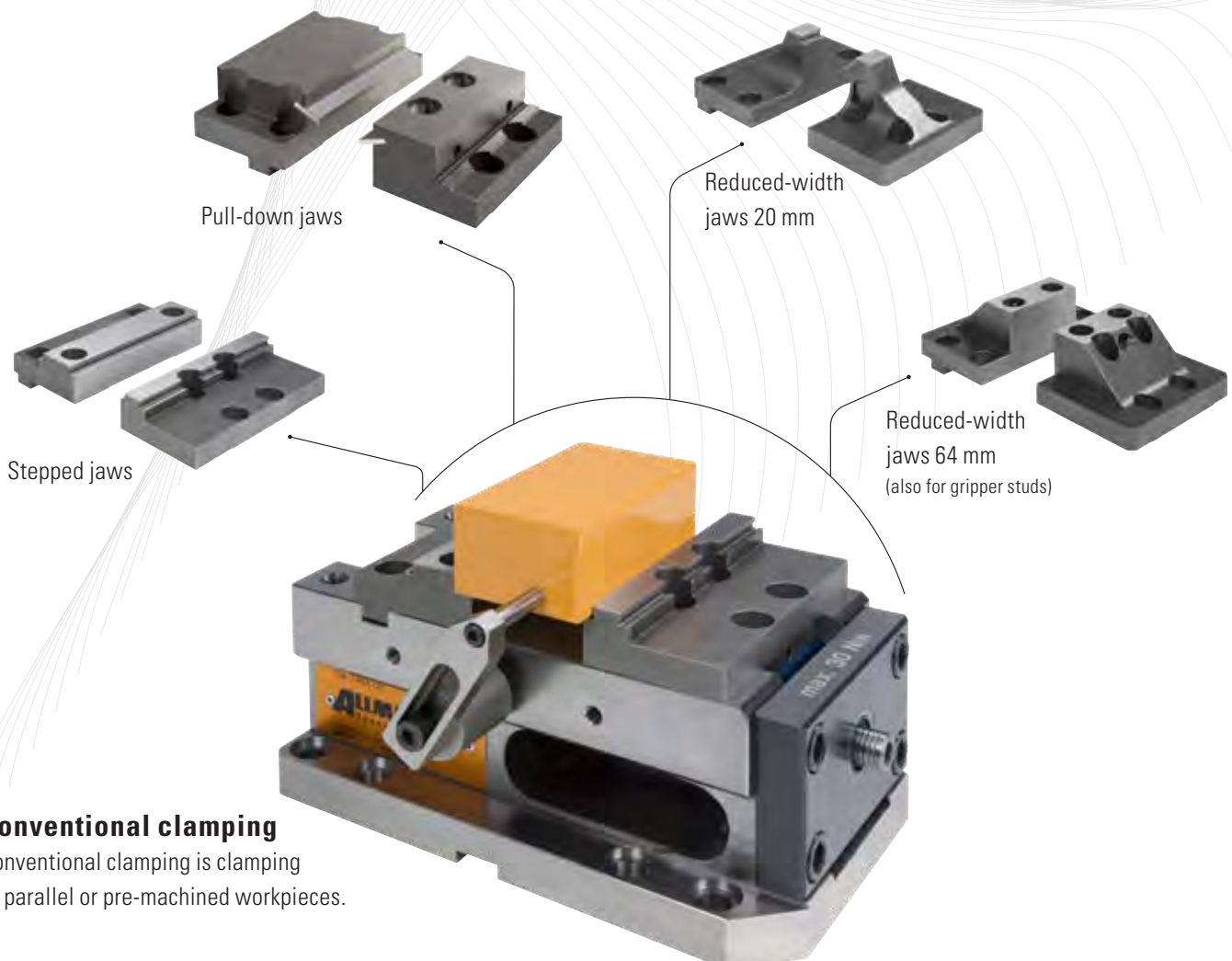

Conventional clamping

Conventional clamping is clamping of parallel or pre-machined workpieces.

GRIPP CLAMPING

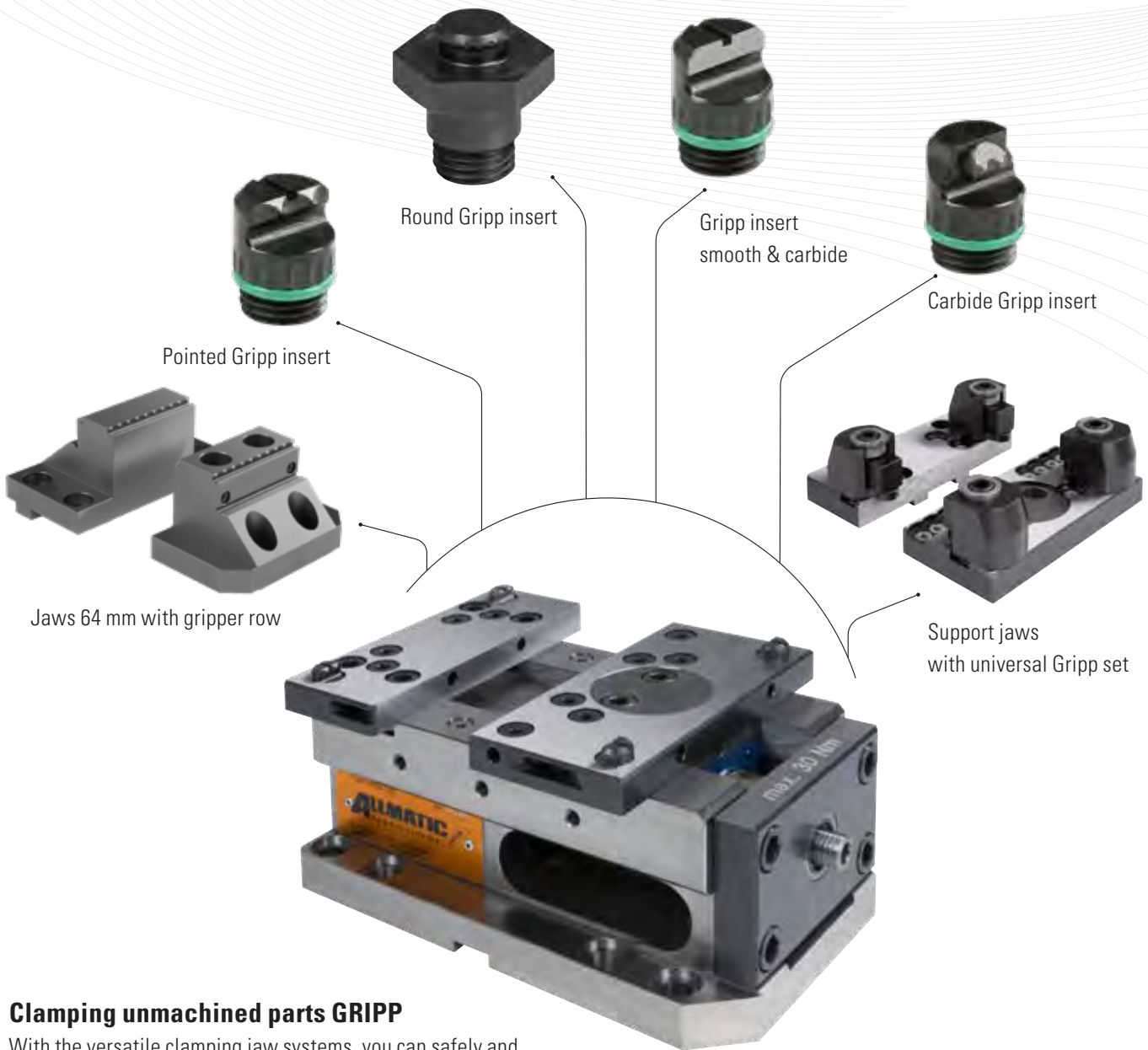

Clamping unmachined parts GRIPP

With the versatile clamping jaw systems, you can safely and quickly clamp unmachined, non-parallel raw materials or workpieces.

The jaw widths of the T-REX depend on the positioning of the Gripp inserts or of the universal Gripp set on the jaw systems.

The geometry which you wish to clamp is irrelevant here. The adjustment options of our Gripp inserts or of our universal Gripp set allow unlimited clamping options.



Technical details are available at www.allmatic.de

TITAN SC 125- SPEED GUARANTEED

The TITAN SC 125 is the entry model in the world of gripper technology. Designed for fast machining from the unmachined part to the finished product. It is equally suitable for Gripp clamping in the first clamping process and for conventional clamping in the second clamping process without re-tooling.

Area of application:

- The classic universal clamp
- Conventional clamping and Gripp clamping possible

Product features:

- 1st and 2nd clamping possible without jaw conversion
- Jaws of the product range LC / TC 125 can be used
- Clamping of unmachined parts and saw cuts (materials up to approx. 1000 N/mm²) due to screw-in Gripp inserts (1st clamping)
- The movable jaw has no pendulum compensation. It is suitable for rectangular workpieces (saw cuts) $l / w \leq 0.5$ (concurrency less than or equal to 0.5 mm) or cylindrical workpieces $D \leq 0.5$ (roundness less than or equal to 0.5 mm)
- Operation with torque spanner
- Provided as standard with locating holes for a zero point clamping system, inside micrometer 200

CONVENTIONAL CLAMPING



Conventional clamping

Conventional clamping is clamping of parallel or pre-machined workpieces.

GRIPP CLAMPING



Clamping unmachined parts with GRIPP

With the versatile clamping jaw systems, you can safely and quickly clamp unmachined, non-parallel raw materials or workpieces. The jaw widths of the TITAN SC 125 depend on the positioning of the Gripp inserts or of the universal Gripp set on the jaw systems. The geometry which you wish to clamp is irrelevant here. The adjustment options of our Gripp inserts or of our universal Gripp set allow unlimited clamping options.



Technical details are available at www.allmatic.de

DUO PLUS 125

SHEER FLEXIBILITY!

The DUO Plus 125 is robust and durable and enables completely new clamping methods.



Area of application:

- Can be used horizontally
- Suitable for conventional clamping and Gripp clamping or a combination of both

Product features:

- Stamping and clamping takes place in one work step
- Clamping width adjustment for clamping of two workpieces of different sizes
- Reproducible clamping forces enable a high reproducibility of the workpiece position



CONVENTIONAL CLAMPING

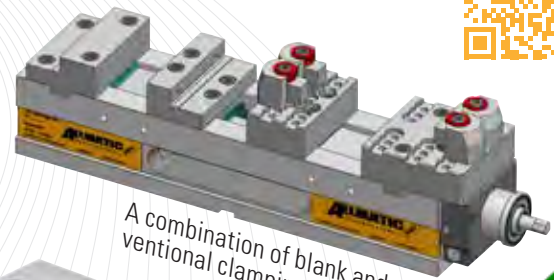

A combination of blank and conventional clamping is possible!



Adapter jaws

Stepped jaws

Mobile pendulum jaw



Conventional clamping

Conventional clamping is clamping of parallel or pre-machined workpieces.

GRIPP CLAMPING

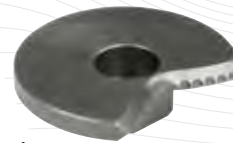
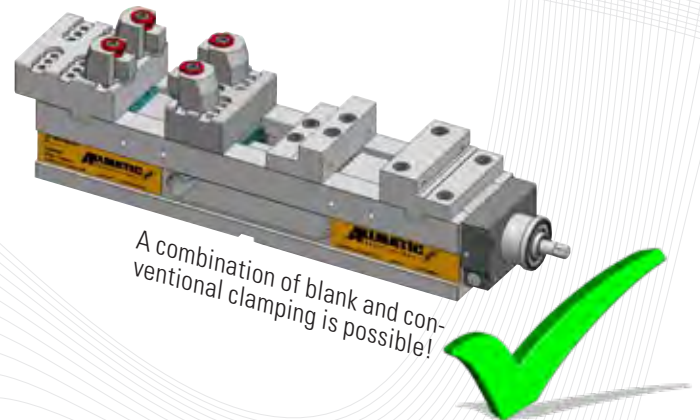
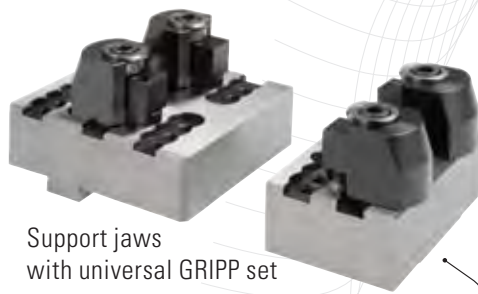

Clamping unmachined parts GRIPP

With the versatile clamping jaw systems, you can safely and quickly clamp unmachined, parallel raw materials or workpieces. The jaw widths of the DUO PLUS 125 depend on the positioning of the universal Gripp sets on the support jaws.

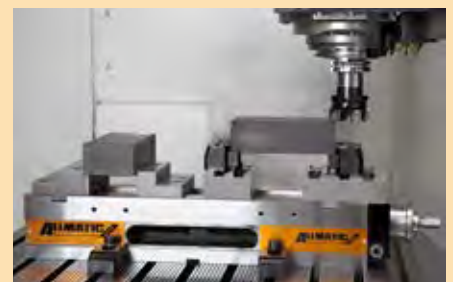

Technical details are available at www.allmatic.de

NC8 FUSION

The NC8 combines the quality and benefits of the TC with the affordability of the LC, plus new time saving features.

LC → FUSION ← TC



Tool-less force setting
TIME - COMFORT



Zero-Point drillings
**FOR YOUR ZERO-POINT
CLAMPING SYSTEM**



QR - CODE
INDUSTRY 4.0
SERVICE-MAINTENANCE

**TC properties for
LC price**
from 1.950,- €



**Including
ground sides**
ACCURACY



Comprehensive product line

NC8 - 90
NC8 - 125 M
NC8 - 125 L
NC8 - 160
NC8 - 200
NC8 - 200^{Heavy Duty}



Fully compatible to LC/TC
-> no extra programming
TIME - SAFETY

Technical details are available at www.allmatic.de

NC8

THE IDEAL COMPANION FOR DAILY MACHINING

The NC8 is the universal vice for a wide range of clamping operations.



NC8 - 90: 6921908000055
Tool-less force setting
in 11 steps



NC8 - 125 M: 6921918000055
Tool-less force setting
in 4 steps



NC8 - 125 L: 6921918010055
Tool-less force setting
in 4 steps



Area of application:

- Ideal for use on 3-axis and 4-axis machining centres
- For conventional clamping

Product features:

- Tool-less force setting with a mechanical stop for safe operation
- Constant, reproducible clamping force with mechanical power-assist
- Proven maintenance-free and encapsulated high-pressure spindle, thus minimised cleaning requirements
- Basic body made of GJS-60
- Guideway inductively hardened and ground
- Aligning grooves in the base face
- Standard with locating holes $\varnothing 25H6 M10$ for zero point clamping systems; inside micrometre $200\text{mm} \pm 0.01\text{mm}$ for models 90 and 125 M
- Lateral boreholes for extension
- Evenness of basic body 0.01mm
- Height of basic body ground -0.02mm
- Width of base body ground -0.05mm , therefore can be used laterally
- Extendable by using the clamping range enlargement for NC8 - 125 M / NC8 - 125 L / NC8 - 160 and NC8 - 200
- Quick-change system for add-on jaws and stepped strips
- Reversible jaws: for min. / max. chuck capacities with one pair of jaws
- Fixed jaw, simple programming thanks to constant zero
- Closing and opening of the complete clamping range including clamping process with a hand crank
- The total length is independent of the workpiece size
- Dimensions NC8 as for LC/TC
- Jaw interface compatible with LC/TC
- Threads for lateral workpiece stops M8
- Connection thread for angle drive
- Individual QR - Code for fast access to technical information, accessories, replacement parts and repair costs

NC8

THE IDEAL COMPANION FOR DAILY MACHINING

The vices of the ALLMATIC NC8 range are characterised by their versatility.

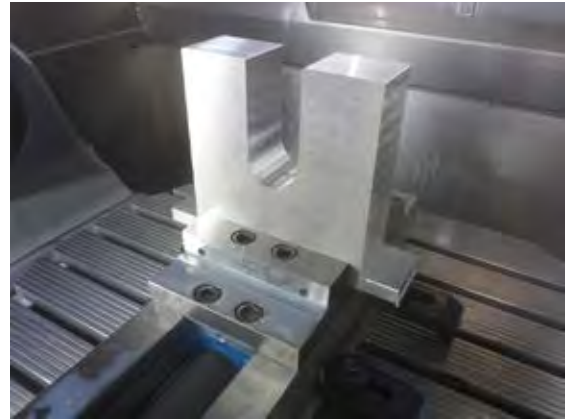

„The tool-less clamping force setting works perfectly“

Jürgen Meschenmoser

Production Manager of the company

MTS - Müller Technical Support from

Kaufbeuren/Germany



Fully compatible to LC/TC

-> no extra programming

Marius Moll

Production Manager of the company

MLB Industrial Services GmbH aus

Bobingen/Germany



Technical details are available at www.allmatic.de

CONVENTIONAL CLAMPING

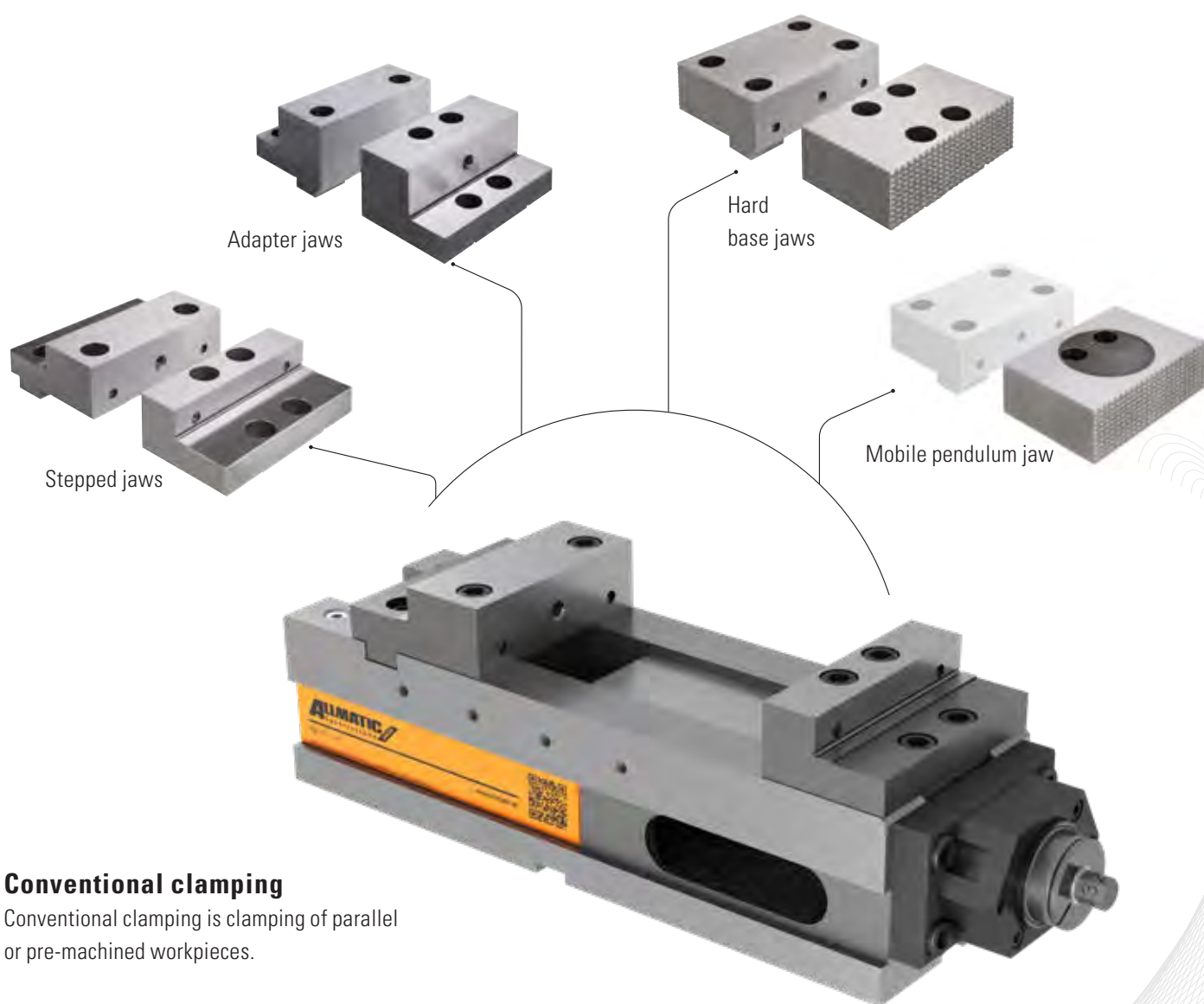

Conventional clamping

Conventional clamping is clamping of parallel or pre-machined workpieces.



Technical details are available at www.allmatic.de

DUO 90

TWICE AS FAST!

If things need to be done quickly, the DUO 90 is the ideal solution for machining your small workpieces.
Reduce your setup time by 50%.



6921478000955

Area of application:

- Can be used horizontally
- Can also be used laterally

Product features:

- Maximum accuracy for machining your workpieces
- Pre-settable, reproducible clamping force in 6 steps.
The max. clamping force can be achieved with 1 revolution
- For clamping of 2 similar parts
(dimensional differences up to ± 3 mm are compensated for)

CONVENTIONAL CLAMPING



Stepped jaws

Stepped strips
Click (pair)



Mobile
pendulum jaw

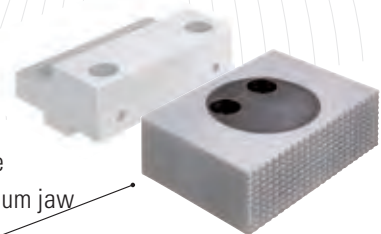

Conventional clamping

Conventional clamping is clamping of parallel or pre-machined workpieces.

Technical details are available at www.allmatic.de

HD

EXTREMELY STRONG AND RELIABLE

The HD has stood for maximum reliability for more than 40 years.
Thanks to its extremely robust design, it is a lifetime investment.



100: 6921011000055
125: 6921021000055
160: 6921031000055

Area of application:

- Suitable for heavy-duty machining, individual pieces and small series
- The tried and tested companion for conventional milling machines

Product features:

- The clamping force pre-setting, 2 to 4 steps, enables pre-setting and reproduction of the clamping forces (type 100 – 2 steps; types 125, 160 – 4 steps)
- Our HD clamp, proven for many years, enables fault-free work with a high clamping force and long-term safety

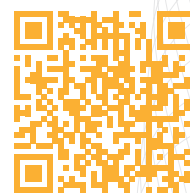

CONVENTIONAL CLAMPING

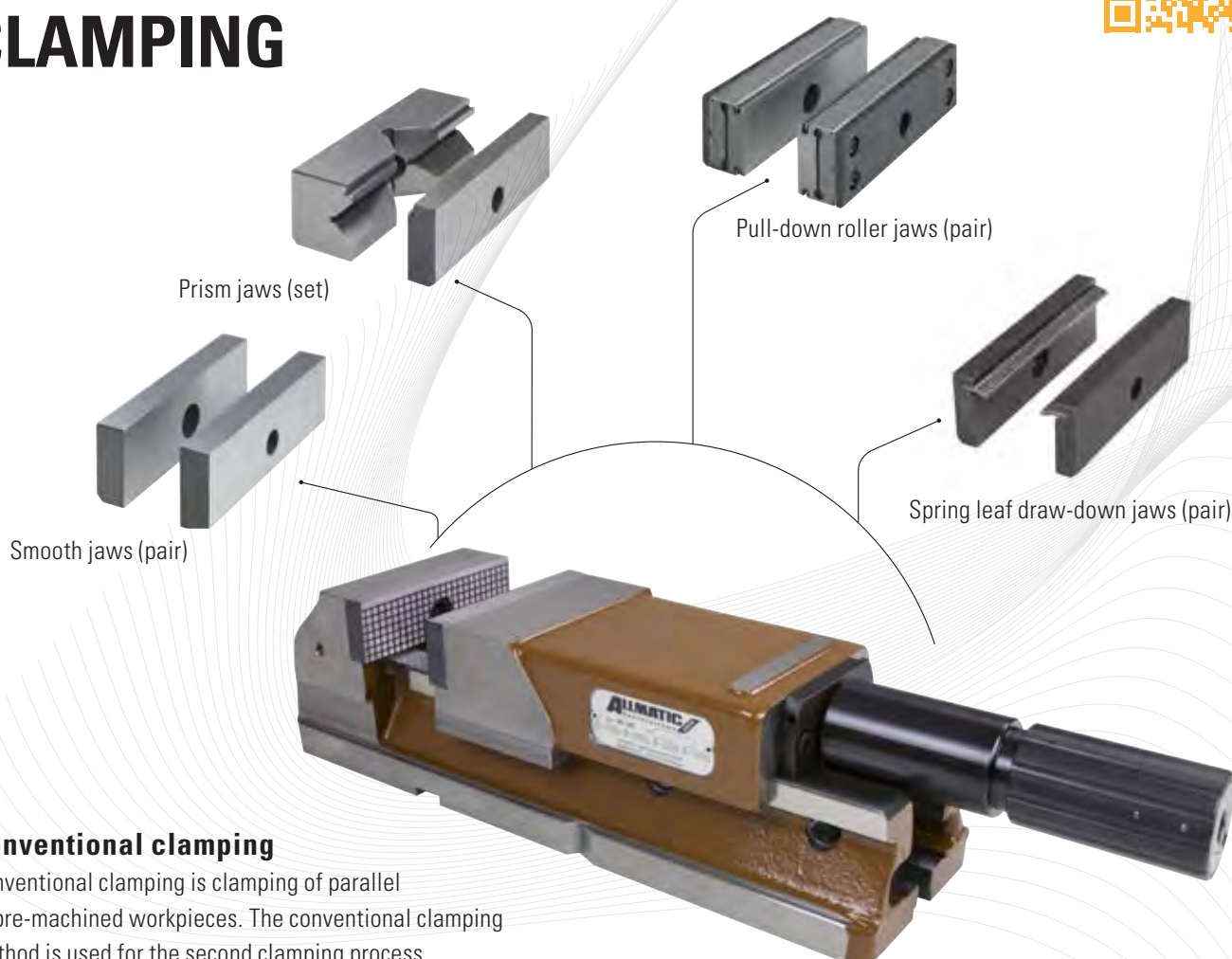

Conventional clamping

Conventional clamping is clamping of parallel or pre-machined workpieces. The conventional clamping method is used for the second clamping process.

Technical details are available at www.allmatic.de

HYDRO AUTOMATABLE CLAMPING

Flexible, exact and very easy to operate – those are the hydraulic clamps from ALLMATIC.
Especially suitable for companies with serial production.

LC - HYDRAULIC



90: 6921678000655

125: 6921688000655

160: 6921708000655

Area of application:

- Can be used horizontally
- For automation of machining centres – especially suitable for serial production

Product features:

- The clamping force is generated via the hydraulic pressure of a hydraulic unit (a hydraulic source is required to operate the vice)
- The hydraulic clamping stroke is limited to max. 4.5 mm due to safety regulations
- The stepless clamping force is set by controlling the hydraulic pressure on the hydraulic unit and approximate setting of the clamping range via the operating tool

CONVENTIONAL CLAMPING

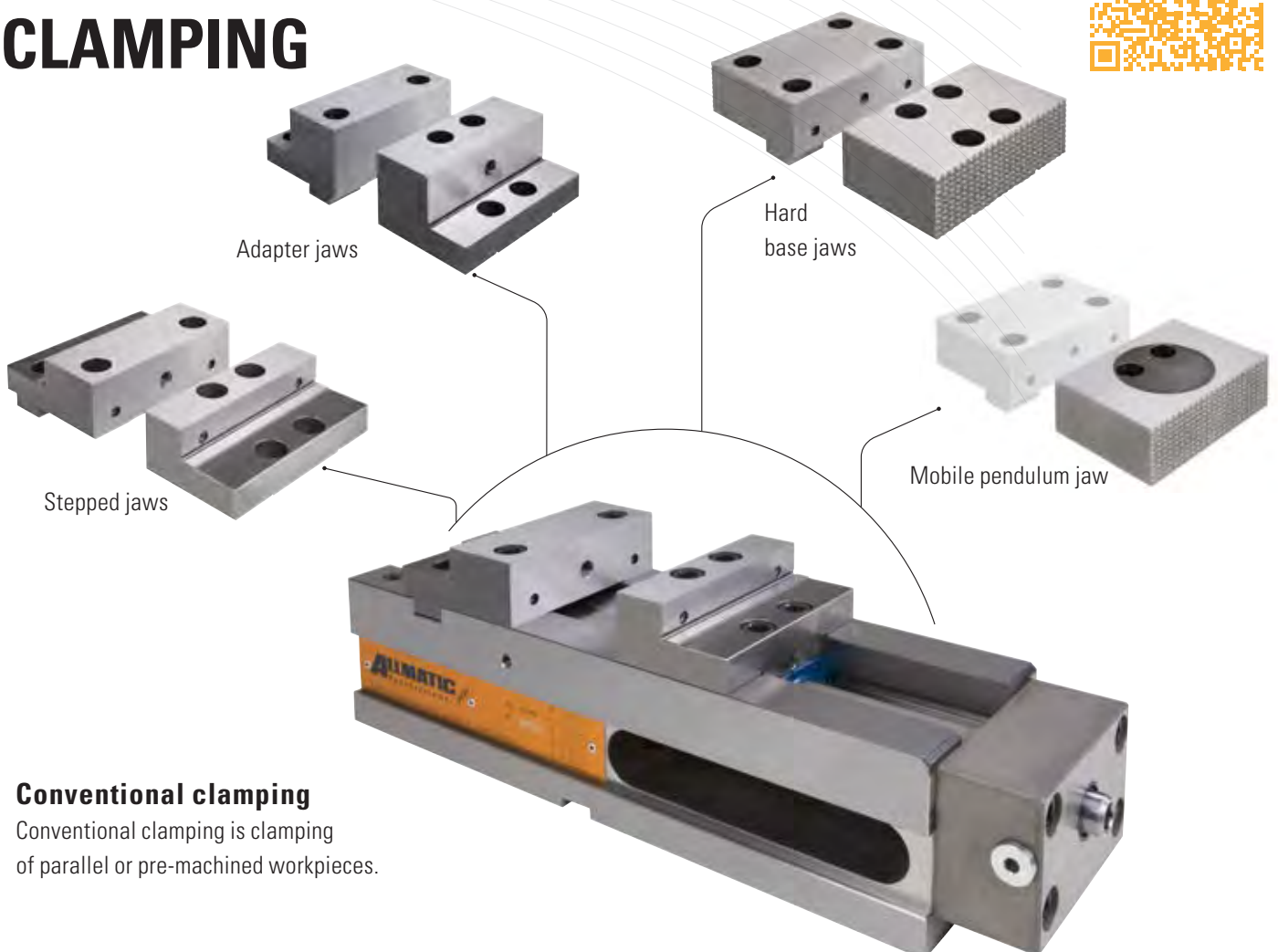

Adapter jaws

Hard
base jaws

Stepped jaws

Mobile pendulum jaw

Conventional clamping

Conventional clamping is clamping of parallel or pre-machined workpieces.

CUSTOMER SERVICE – OUR SPECIALISTS ARE THERE FOR YOU



Mr Guggenmoos, Sales

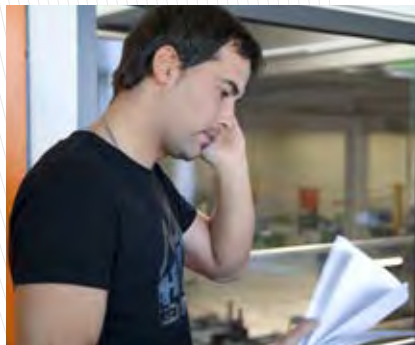

Mr Orban, Production Control



Ms Guggenmoos, In-House Sales

Information by phone

+49 8377 929-0

Orders by fax

+49 8377 929-380

Orders by e-mail

order@allmatic.de

Our repair service

+49 8377 929-358

For information on delivery periods and prices or technical information, we are available in person from Monday to Friday 8.00 – 16.30 (Friday until 15.00).

Our repair department can be contacted daily from 8.00 – 15.00.

Delivery

We deliver standard products within the Federal Republic of Germany CPT carriage paid.

Minimum order value

Our minimum order value is € 20.

ALLMATIC Online: www.allmatic.de

Various sales promotions, new products, reduced products in sales and service drawings for a possible replacement parts order. All this can be found on our website.

Complaints

In the event of incorrect orders, we charge a 5 % processing fee of the net value of goods but at least € 25. The period for returns is three months. Specially produced products are excluded from return or replacement.

Further information

You can also download 3D data, brochures and operating manuals from **www.allmatic.de**

Terms and Conditions

Our Terms and Conditions are available at **www.allmatic.de**



**For long-term protection of our resources!
For further technical information, follow the QR Code.
Support ALLMATIC in environmental protection!**

ALLMATIC-Jakob Spannsysteme GmbH
Jägermühle 10, 87647 Unterthingau, Germany
Phone: +49 8377 929-0
Fax: +49 8377 929-380

E-mail: info@allmatic.de
www.allmatic.de
www.allmatic.ch